

TOP 5

Petrochemical Applications

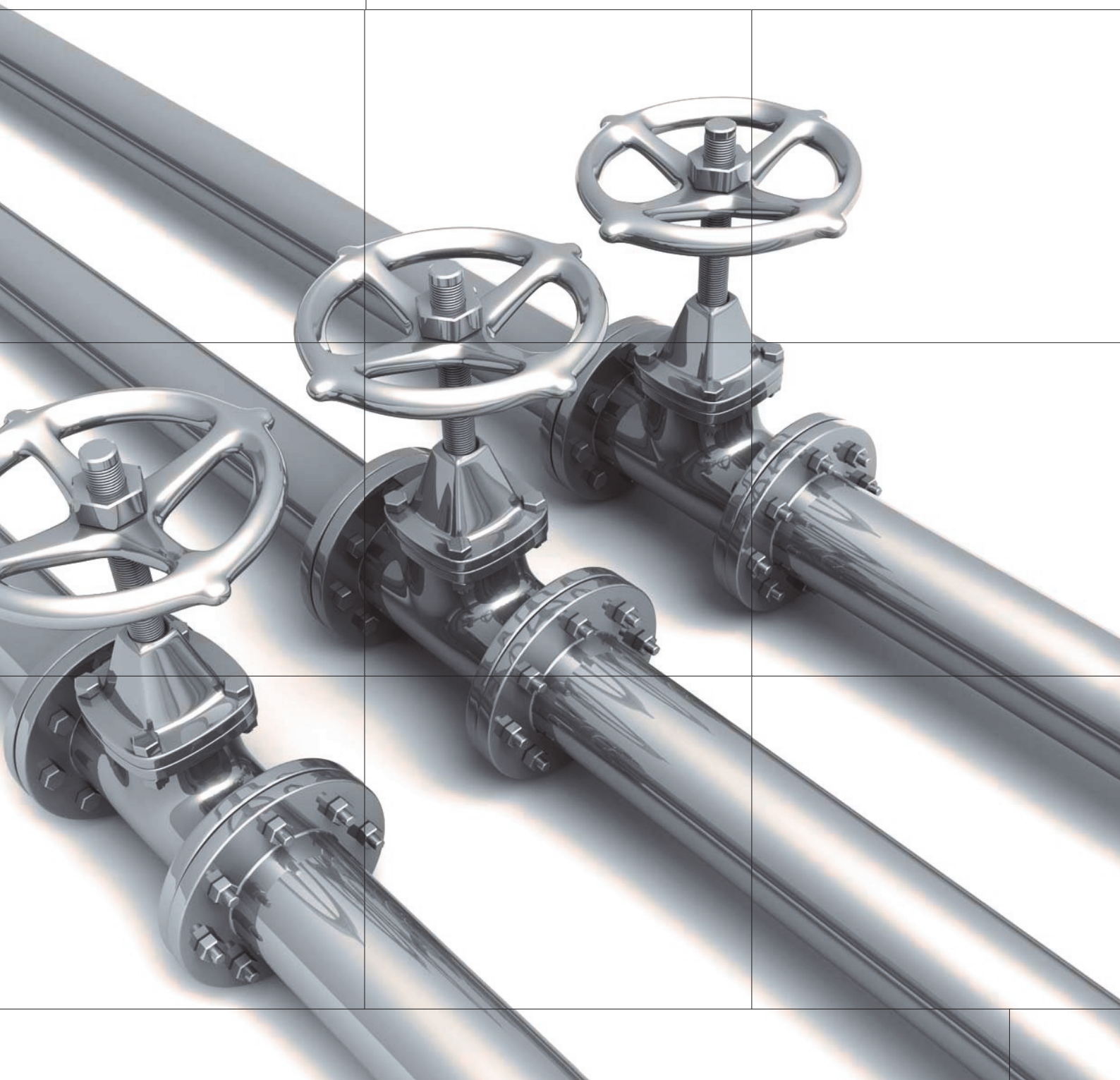

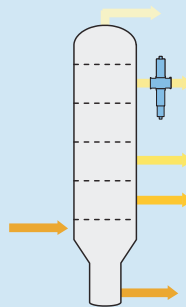

TOP 1 Color of Refined Fuels

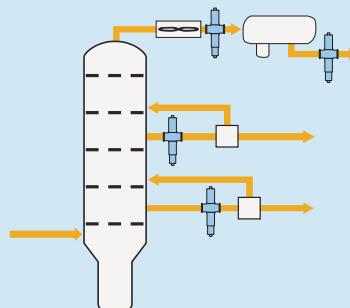

TOP 2 Naphtha Quality in Crude Distillation Unit

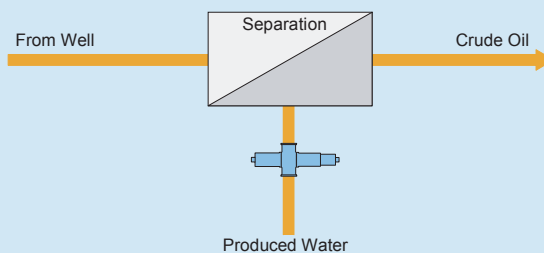

TOP 3

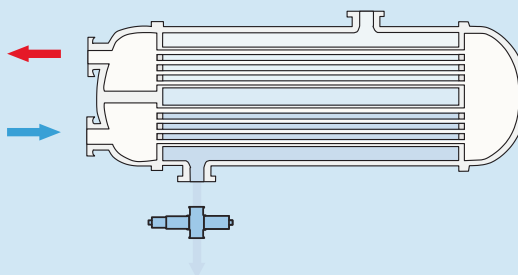

TOP 4 Condensate and Cooling Water

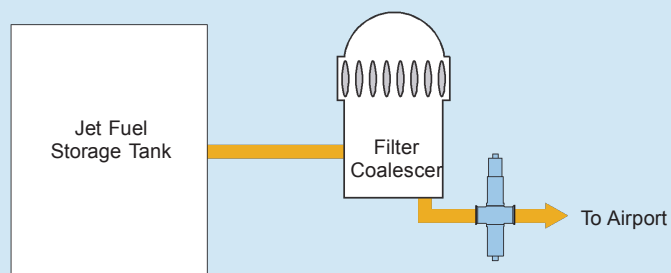

TOP 5 Fuel Analysis: Water in Fuels



Content

TOP 5 Petrochemical Applications

TOP 1	Color of Refined Fuels	04
TOP 2	Naphtha Quality in Crude Distillation Unit	06
TOP 1	Oil in Produced Water	07
TOP 4	Condensate and Cooling Water	08
TOP 5	Fuel Analysis: Water in Fuels	10
	Principles of Measurement	11
	Contact	12

In many stages of petrochemical processes, Modcon photometers help to ensure optimum system performance.



MODCON

Modcon is the world's leading manufacturer of inline photometric process instrumentation. With more than 30,000 installations in various applications and industries, our team provides the best in quality, consulting, support and long term performance, worldwide.

Modcon process photometers provide reliable and accurate industrial process control for liquids and gases. Utilizing UV, VIS & NIR absorption and scattered light technology, Modcon photometers measure inline for continuous processing. Superior materials of construction make Modcon photometers ideal for applications in high temperature, high pressure, and corrosive process streams.

As a global partner to the petrochemical industry, Modcon offers advanced technologies such as superior signal amplification, inline calibration support, PROFIBUS® PA, and multilingual user interfaces for easy onsite operations. Our support ensures long term satisfaction with programs like "SpeedParts" and "SwapRepair" to provide our customers sustainable operations and minimal down-time at the lowest cost of ownership.

Optimize your process with Modcon.

04 | Color of Refined

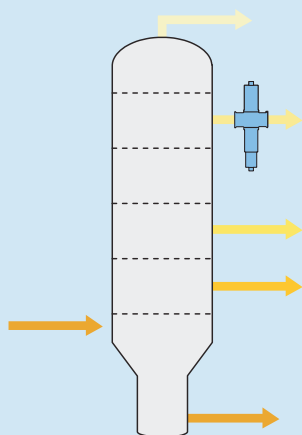

TOP 1

www.modcon-systems.com

The petroleum refining and petrochemical industries benefit greatly with the use of inline color measurements. Detecting color changes directly in the process stream alerts refinery personnel of immediate process upsets that may affect final product quality.

Historically, monitoring color changes was accomplished with a “grab sampling” technique and/or relied on human interpretation comparing samples against ASTM, Saybolt, or other color standards. Today, these measurements are done with precise and reliable in-line color sensors from Modcon.

Fuel Contaminant Monitoring

Often, color changes are a signal for contaminations in fuels. Detecting these contaminants directly inline allows operators to redirect the process for further refining or re-distillation. Installing multiple inline color sensors throughout the refinery can also be beneficial in locating the sources of contaminations.

Petroleum Product Color

The petroleum refining and petrochemical industries rely on Saybolt and ASTM color scales (among others) to quantify product quality. Modcon inline Saybolt and ASTM sensors allow refineries, pipeline companies and storage facilities to measure and monitor these color values directly in the pipeline.

Color Measurement

Modcon MOD-A26 dual channel sensors compensate for background turbidity or other media constituents automatically using a secondary wavelength. The primary wavelength usually detects color and background turbidity, whereas the secondary wavelength only detects background turbidity or other media constituents. Subtracting the absorption signal of the reference channel from the primary channel gives a compensated signal that is then correlated to any color scale, independent of background interference.

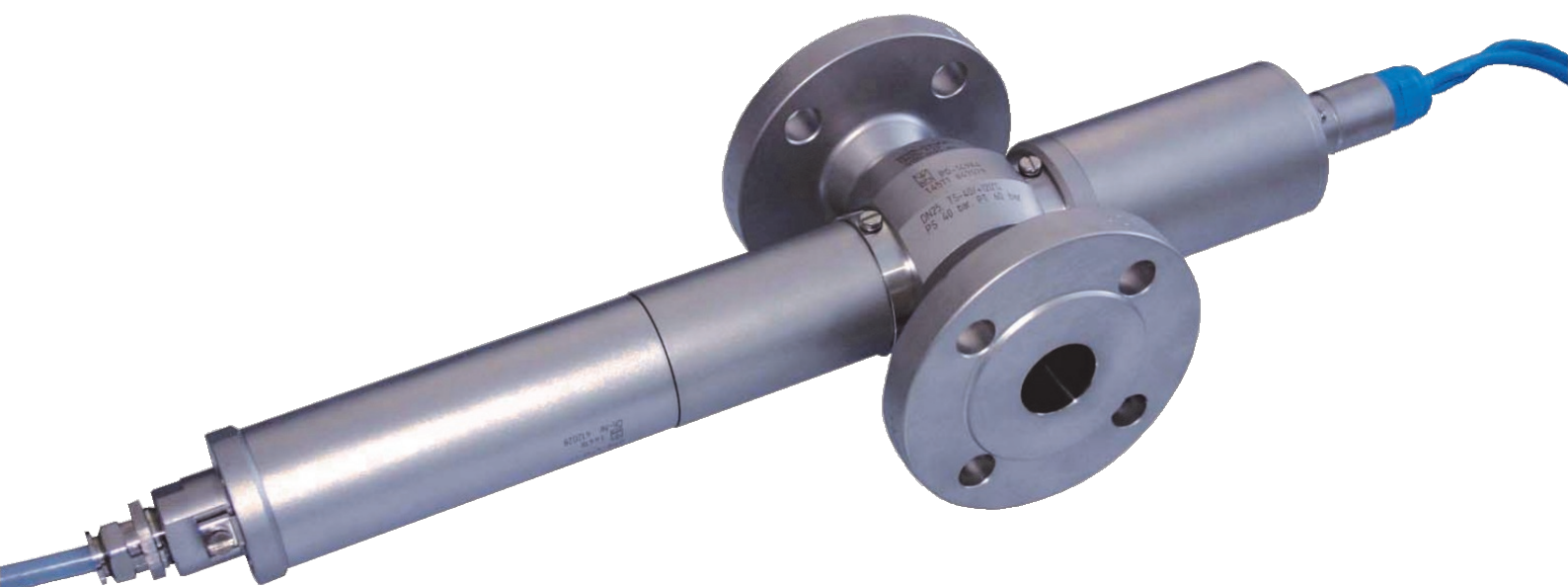

Modcon MOD-A26-EX Dual Channel Absorption Sensor

Phase Separation

Using real-time data provided by Modcon MOD-A26 inline color sensors, pipeline operators are able to cut product or detect product interfaces precisely. This monitoring ensures that fuels are not downgraded by intermixing of low quality products. Throughout the entire production process including terminaling facilities, fuel color can be monitored in order to ensure specifications and minimize product losses.

Benefits

Ensuring product quality and fuel grade inline minimizes out of specification product. Detecting process upsets in real-time protects downstream equipment and maximizes efficiency at the lowest cost of ownership.

Automation

Modcon MOD-C-4000 converter transmits measurement signals to the PLC or plant DCS using up to four mA-outputs. Remote signals from the PLC or plant DCS can be sent to the C4000 converter to zero the instrument or to hold output signals. Additionally, PROFIBUS® PA communication is available for advanced control systems.



Modcon MOD-C-4000 Photometric Converter

06 | Naphtha Quality in Crude Distillation Unit

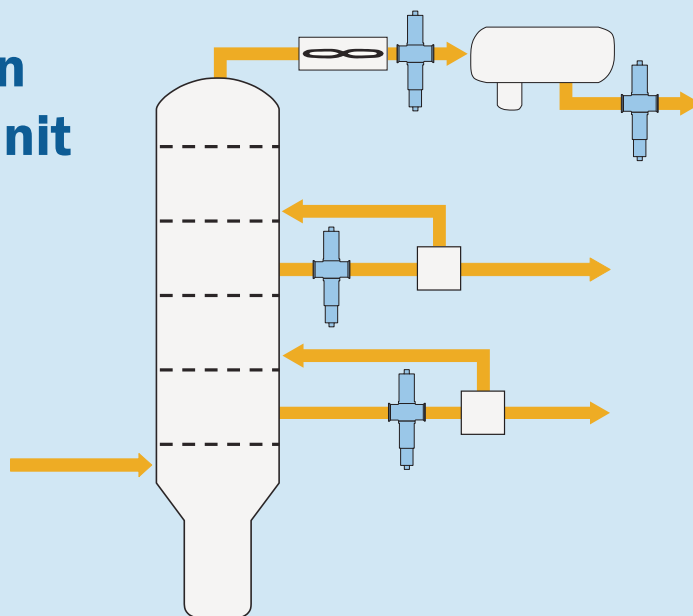

Distillation

The quality of fractions from the crude distillation unit (CDU) needs to be continuously monitored. By installing Modcon inline photometer, the refinery maintains peak performance from the column and controls product quality downstream.

Color Scales

Naphtha, gasoline, kerosene and jet fuels are the lightest and highest quality hydrocarbons drawn off the top of the distillation column. Because of their low levels of impurities, they normally have a clear visual appearance. Their color is measured using the Saybolt color scale, ranging from brightest +30 to darkest -16, where

acceptable product quality typically measures between +27 to +30. Heating oils, gas oils and lubricating oils are heavier hydrocarbons that are darker in appearance and drawn from the middle of the distillation column. Their color is measured using the ASTM color scale, ranging from brightest 0 to darkest 8, where acceptable product quality typically measures between 3 to 4. Using Modcon MOD-A26 sensor in conjunction with the MOD-C-4000 converter, the refinery operator can continuously monitor the color of any refined hydrocarbon in any color scale. This allows for real-time determination of process upsets, eliminating poor quality products while maximizing process efficiency.

Contamination Detection

Increased color intensity typically indicates the presence of undesirable contamination resulting from a process upset or a reduction in process efficiency. Upsets generally occur when the heavier hydrocarbon fractions, such as crude, are carried upward with the lighter fractions, resulting in the contamination of the naphtha stream.

If not detected immediately, the contaminated naphtha will feed downstream, damaging plant equipment and reducing product quality.

Continuous Monitoring

By installing Modcon inline color sensor, the naphtha stream will be continuously monitored in real-time. The MOD-A26 explosion proof sensor will immediately detect color changes caused by upsets or gradual reduction in process efficiency. Even at high pressures and temperatures, these important color measurements are made without the need for sample conditioning.

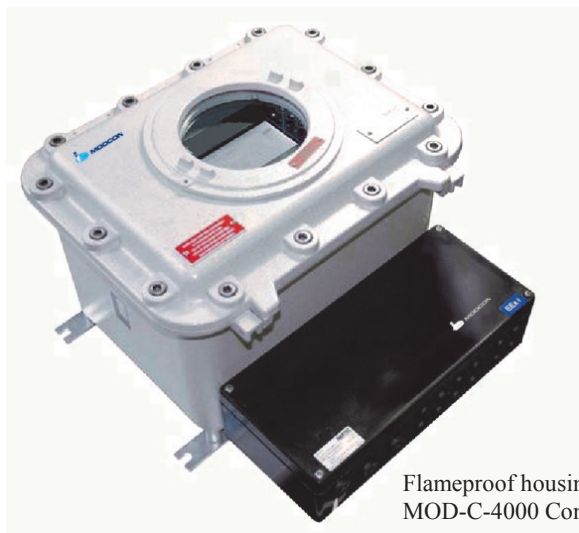

Flameproof housing Ex d for Modcon MOD-C-4000 Converter

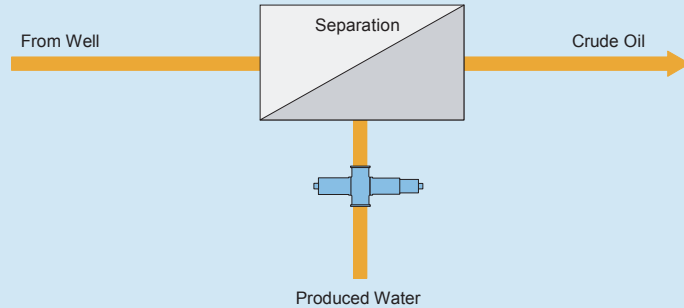

Produced Water

When crude oil and natural gas are extracted from the ground, undesirable constituents such as water, sand, and other contaminants are also extracted. These constituents are separated, and the water portion of the separation is known as produced water. Produced water will contain some level of hydro-carbons that must be further separated before it can be disposed of or used in subsequent operations. To conform to strict environmental standards and to improve produced water management, it is important to monitor the water quality at various points in the separation process. Modcon inline photometers can be used to monitor this process on production platforms or land based water treatment sites.

Oil in Produced Water Separation

Modcon oil-in-water sensors are typically installed after final filtration or separation to monitor both the efficiency of the process and to verify the filtrate meets accepted environmental standards.

Measurement

Modcon MOD-T16-N turbidity sensors can detect very low levels of oil using scattered light technology. Because this technology is much more sensitive to particles like oil droplets in water, it is the preferred monitoring technique compared to absorption based technology. Furthermore, Modcon inline sensors meet all area classifications of the production unit and can be supplied with ATEX or FM certifications.

Benefits

Modcon inline sensors help minimize reprocessing costs by immediately detecting changes in produced water quality. At the same time, environmental pollution fines can be eliminated and throughput can be maximized.

Modcon MOD-T16-EX -N
Dual Channel Turbidity Sensor

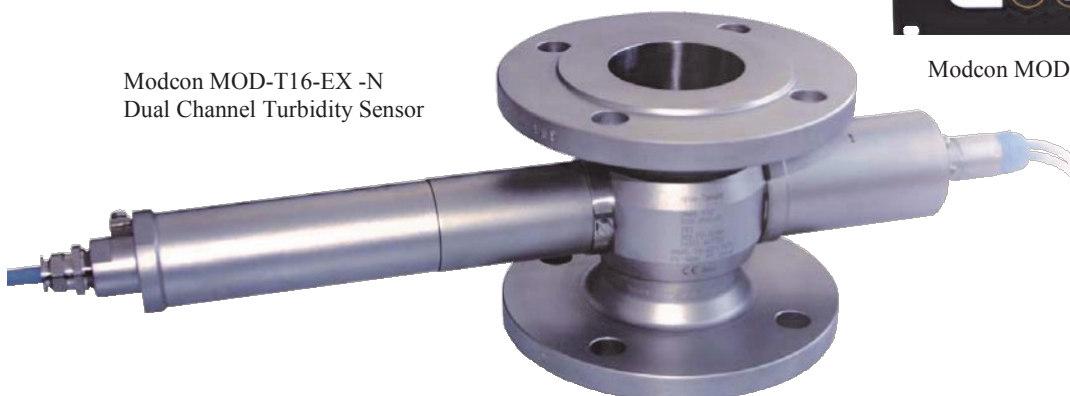

Modcon MOD-C-4000 Photometric Converter

08 | Condensate and Cooling

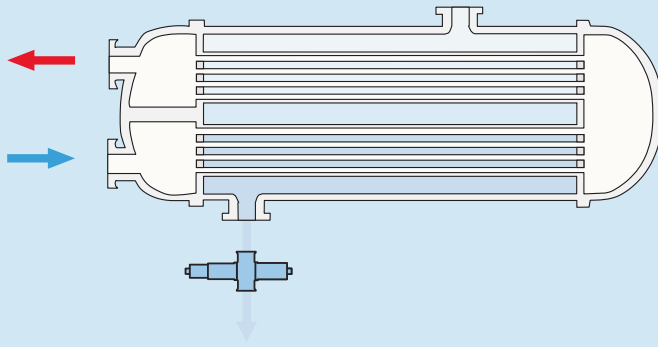

TOP 4

www.modcon-systems.com

Heat Exchanger Leak Detection

Heat exchanger leak detection is an important standard application for many processors. Companies in all industries increasingly demand the measurement of oils, aromatics, or undissolved hydrocarbons in the ppm range. For this purpose, Modcon inline photometers have been proven worldwide as a reliable solution.

Trace oil in water detection provides advanced warning of oil contamination in water or condensate streams. Modcon MOD-T16-N scattered light turbidimeters can easily detect trace contamination in heat exchanger cooling, heating and reclaim lines.

By using Modcon photometers in heat exchanger cooling/heating lines, a pinhole leak can be detected and repairs can be made before an expensive breakdown occurs. Also, operating costs are reduced because heat exchanger maintenance can be scheduled to minimize process downtime. This ensures proper operation of the heat exchanger and reduces the risk of bacterial growth in the heating/cooling system.

Condensate

Modcon photometers ensure that condensate is free from contaminants allowing it to be reused for boiler feed or other processes. This has proven to be an extremely beneficial process improvement, reducing water usage, treatment chemicals, and wastewater costs.

Carryover

There is a chance of carryover in any area where water is used to heat or cool the process stream. Modcon inline photometer is an excellent tool for immediate detection of process contaminants.

In applications where the process stream consists of undissolved oil or solids, Modcon MOD-T16-N scattered light turbidimeter can detect the total particle content. By measuring in the Near Infrared (NIR) the measurement will not be affected by color or color changes.



Modcon MOD-T16-EX-HT-N Scattered Light Dual Channel Turbidity Sensor



Modcon Stainless Steel Housing with MOD-C-4000 Converter

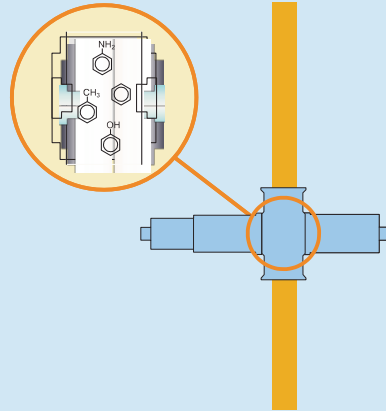

Detecting contamination in other ways, such as UV or color (yellowness) may also be advantageous for dissolved hydrocarbons, oils or aromatics. This is especially true for processors who are reusing condensate or reboiler to conserve energy, water and chemical usage.

Inline Monitoring

Using continuous inline sensors, carryover can be detected and isolated before complete failure occurs. Modcon process photometers help to protect the process and get the most out of valuable utilities. Easy to install and implement, Modcon photometers provide a rapid return on investment.

Protection of equipment and the detection of leaks or carryover are possible using process photometers. Additionally, the reduction of water usage, contamination risks, heat exchanger downtime, and energy consumption are just a few of the benefits using Modcon inline sensors.



Modcon MOD-C-4000 Converter

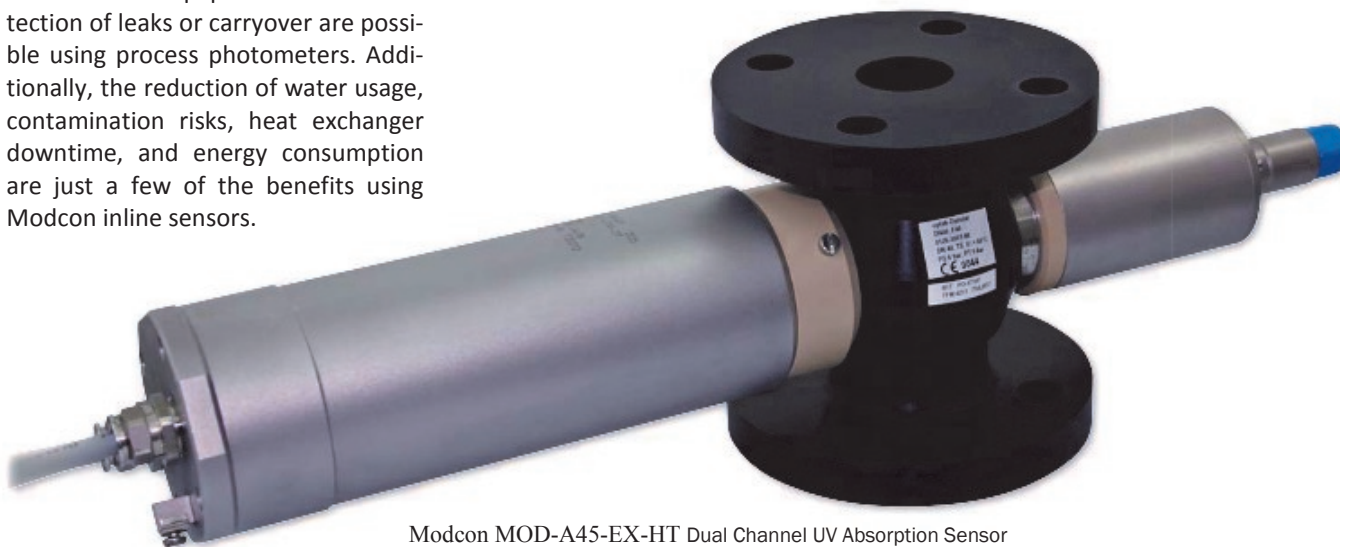

Modcon MOD-A45-EX-HT Dual Channel UV Absorption Sensor

10 | Fuel Analysis: Water in Fuels Water

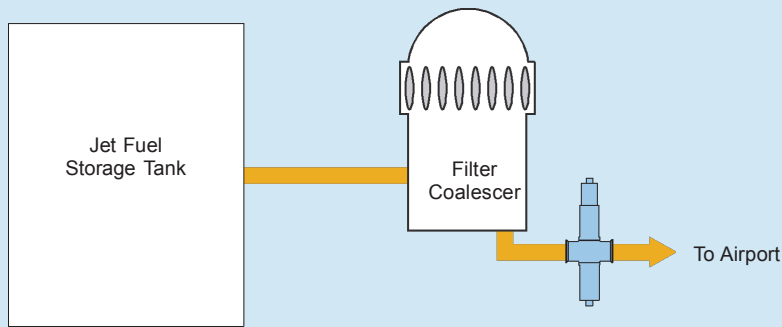

TOP 5

www.modcon-systems.com

Fuel Analysis

Fuel analysis is a very important part of the refining process. By continuously monitoring free water and suspended solids in refined fuels, operators can immediately detect inefficiencies or failures in filters, coalescers or separators and identify the presence of possible contamination from other sources.

Modcon dual beam scattered light turbidity sensors are used at refineries before distribution, at receiving and delivery pipeline terminals, and at airports before final loading. Proven Modcon performance using remote inputs and optional PROFIBUS® PA communication make it possible to use these systems in remote areas.

Water in Jet Fuel Detection

There are numerous potential contamination sources along the process. Nominal limits for free water in jet fuel are typically in the range from 0-15 ppm (DE) while other fuels may tolerate larger ranges. Modcon MOD-T16-N scattered light turbidity sensor will immediately detect these low level contaminations. This important inline measurement is accomplished in real-time and designed for harsh and hazardous area classifications.

Fuel Filtering/Coalescing Contamination

Water and suspended solids are removed during the production, transportation and loading of fuel. Despite these process controls, potential contamination sources still exist. Modcon T16-N scattered light turbidity sensor installed after a filter or coalescer immediately detects a failure or filter break. Contaminated fuel can then be diverted into a holding tank for further processing while uncontaminated fuel is moved down the process.



Modcon MOD-T16-EX-N Dual Channel Turbidity Sensor

11 | Principles of Measurement



Sensor MOD-A16

VIS- and NIR-Absorption, single channel concentration and color measurement

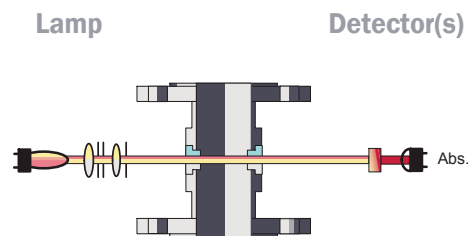

Sensor MOD-A26

VIS-Absorption, dual channel color measurement with turbidity compensation

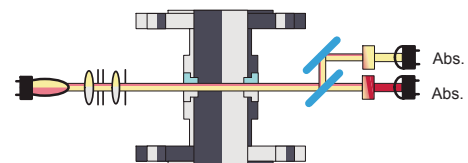

Sensor MOD-A45

UV-Absorption, single channel concentration measurement with compensation of lamp intensity

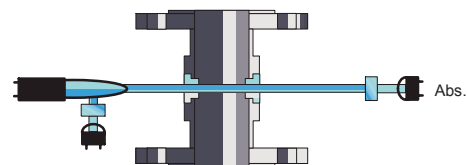

Sensor MOD-A46

UV-Absorption, dual channel concentration measurement with compensation of lamp intensity

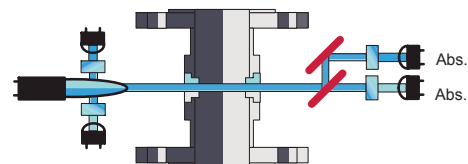

Sensor MOD-T16

11° Scattered Light and NIR-Absorption, dual channel turbidity measurement

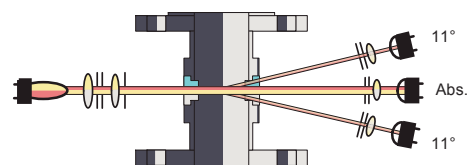



SYSTEMS LTD

Registered in England and Wales with company number 07794530
Suite 1674, Lower Ground Floor, 145-157 St John Street, EC1V 4PW
T/F: +44 (207) 5043626
www.modcon-systems.com

 **Azerbaijan**

Heydar Aliyev avenue 74/17 Baku AZ 1033
Tel: +994-12-4189859
Fax: +994-12-4929859

 **Israel**

Bornshtein St. South Akko Ind. Park, Acre 24222
Tel: +972-4-9553955
Fax: +972-4-9553956

 **Romania**

Aleea Emil Botta, Nr. 4, BL. M104
Sc. 2, Et. 4, Ap. 56 Sector 3, Bucharest RO-031074
Tel: +40-21-3260533
Fax: +40-21-3260552

 **Россия**

Перовская улица 61/2, стр. 1 Москва 111394
Тел.: +7 (495) 9891840
Факс: +7 (495) 9891840

 **UK**

Suite 1674, Lower Ground Floor
145-157 St John Street, EC1V 4PW
Tel: +44-207-5043626
Fax: +44-207-5043626

 **USA**

2000 Broadway Street
Suite #1203 San Francisco, CA 94115
Tel: +1-917-5916880
Fax: +1-360-2375906